

voorgevel
1:100

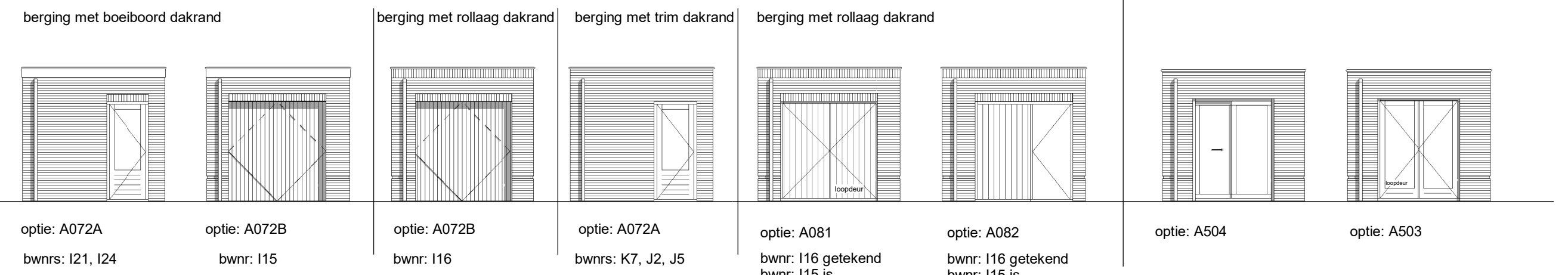

achtergevel
1:100

begane grond
1:50

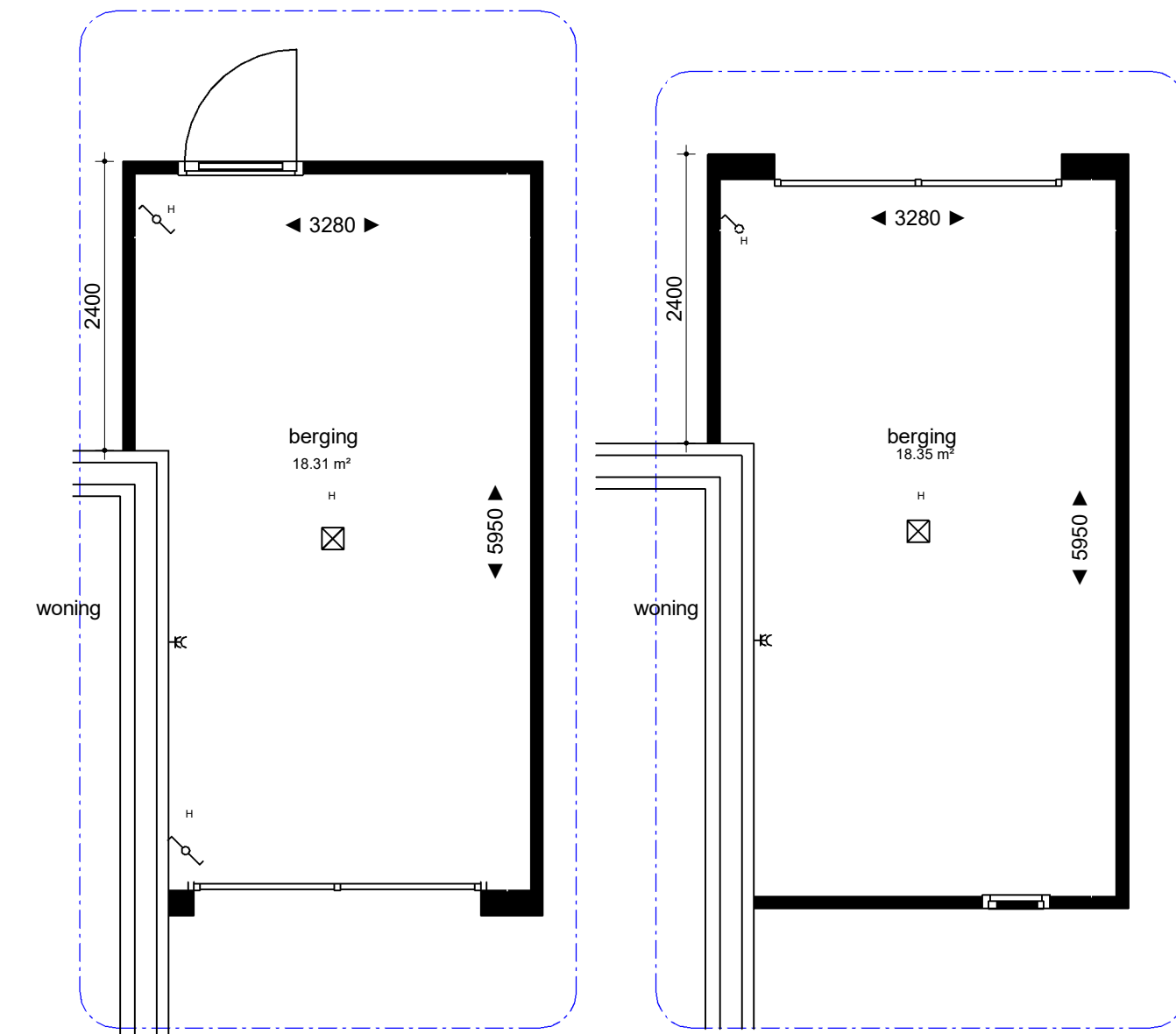

optie: A072A
bwnrs: K7, J2, J5

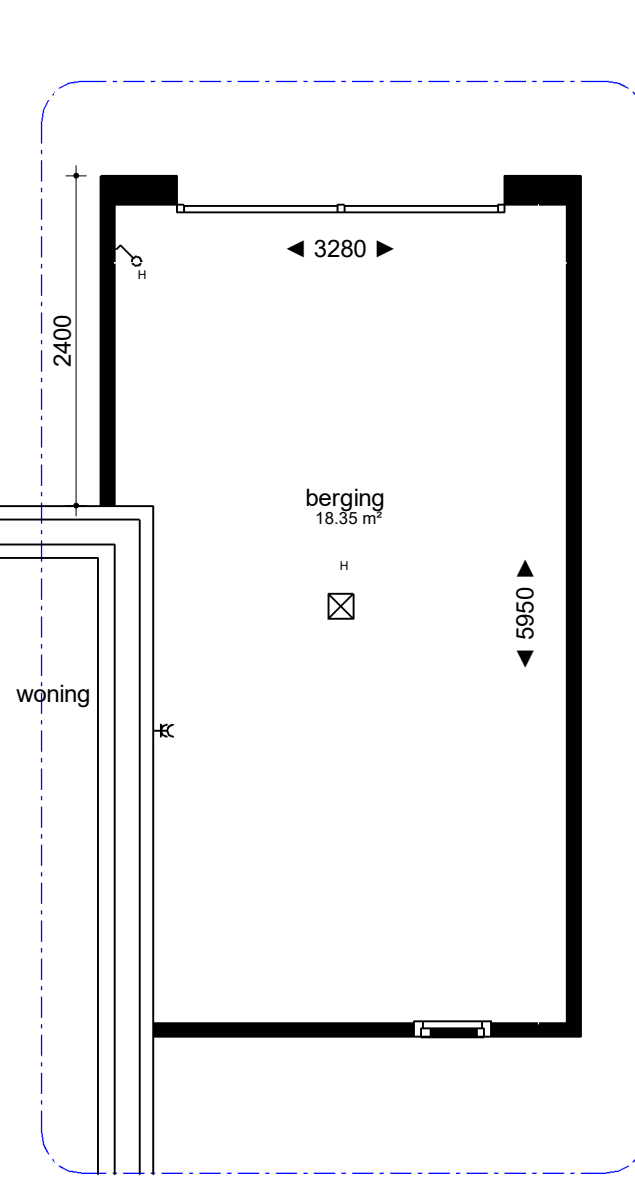

optie: A072B
bwnr: I16

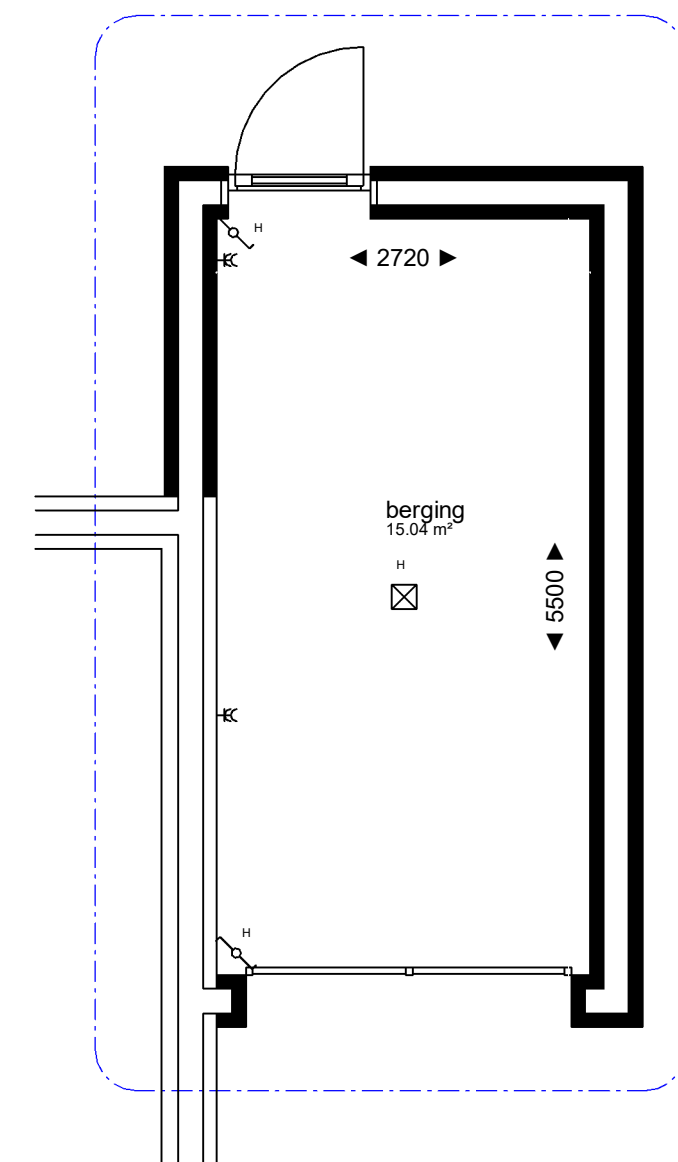

optie: A073A
bwnr: I21, I24, K7, J2, J5

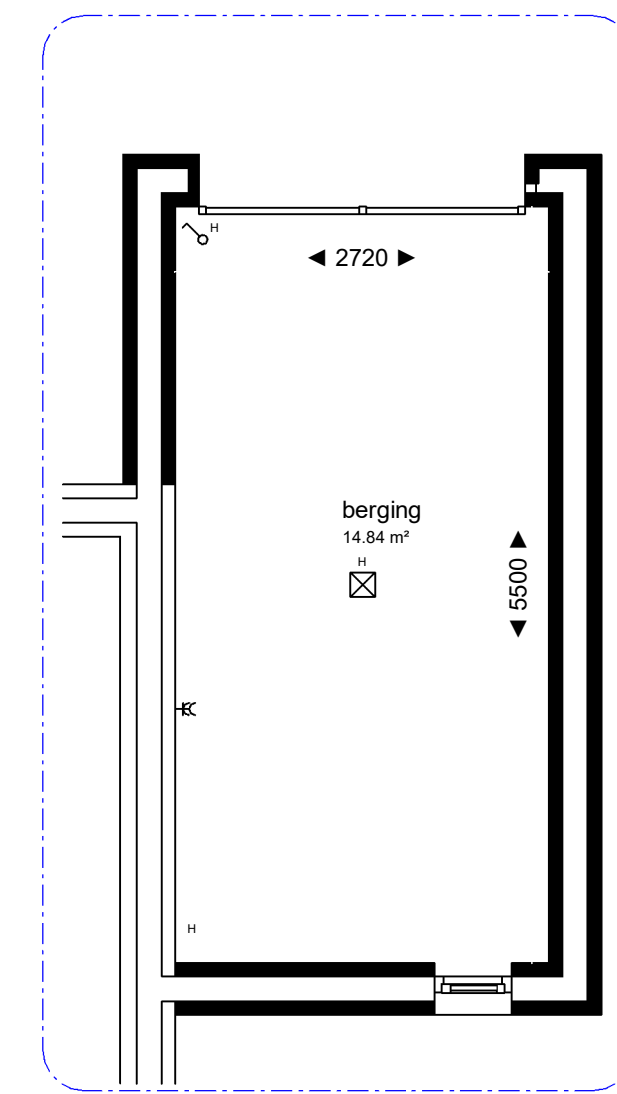

optie: A073A
bwnr: I15, I16

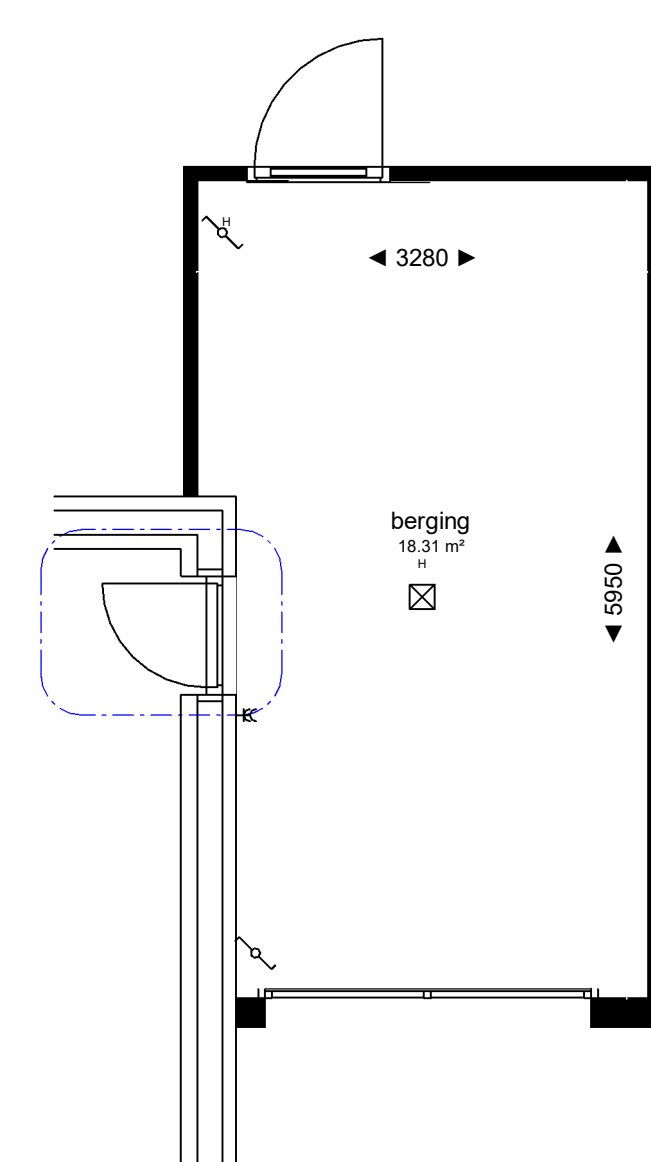

optie: A079A

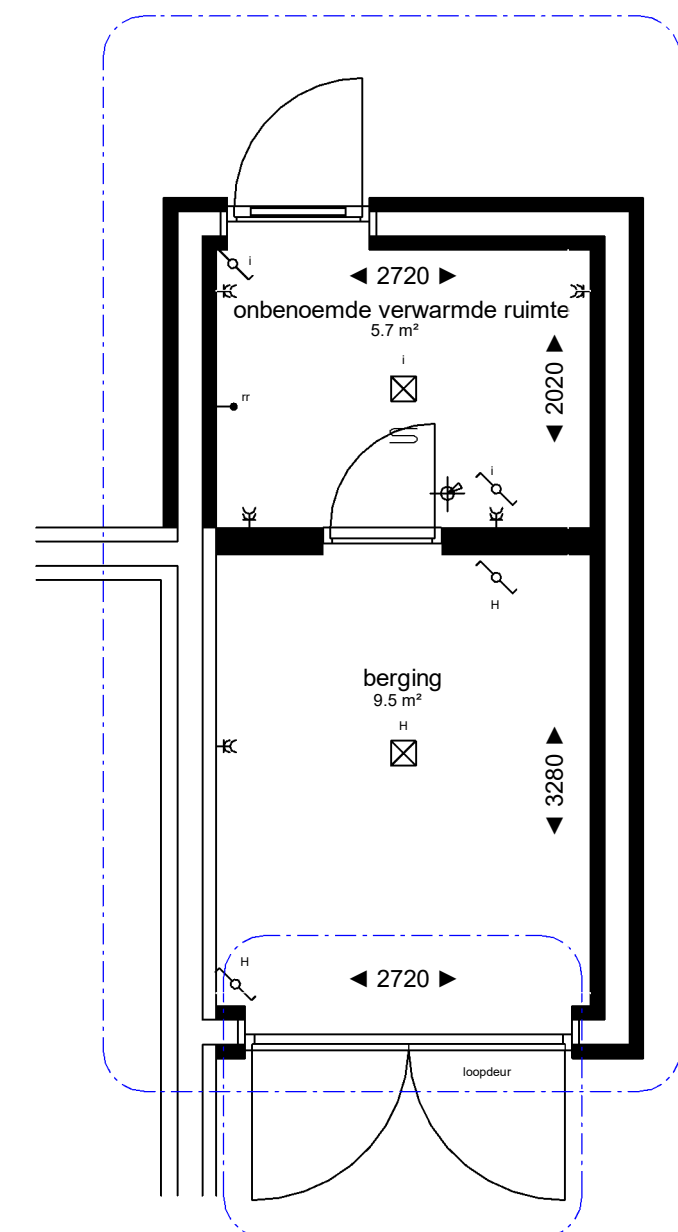

optie: A502A / A081
bwnr: I21, I24, K7, J2, J5

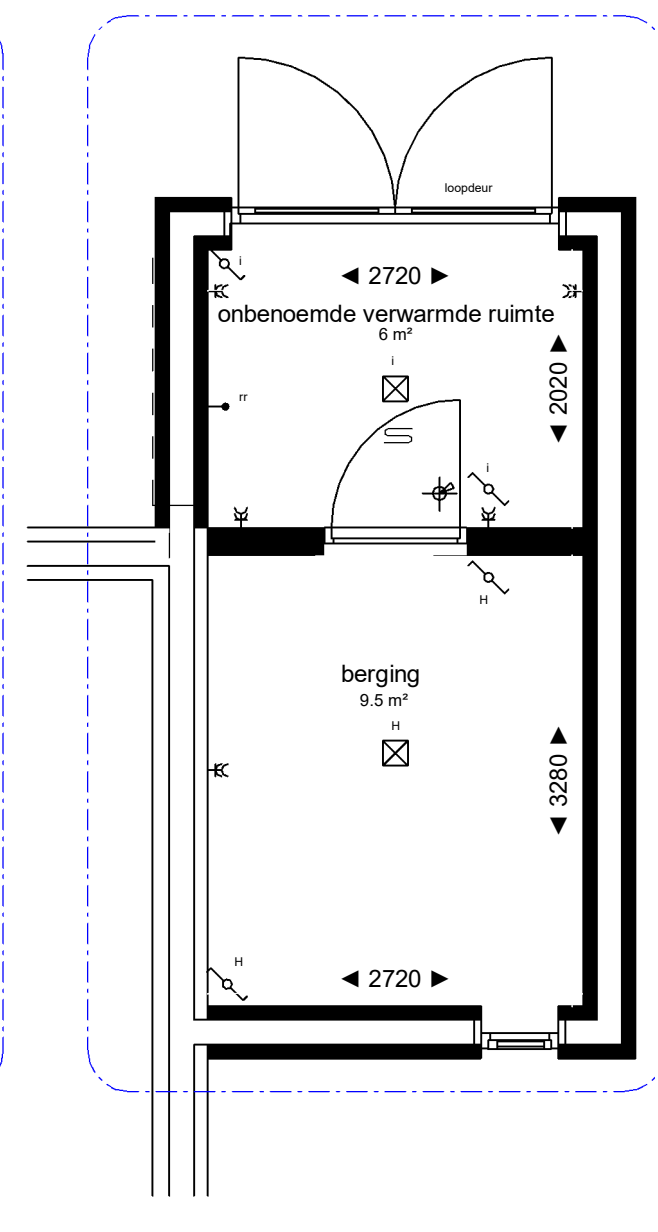

optie: A502B
bwnr: I15, I16

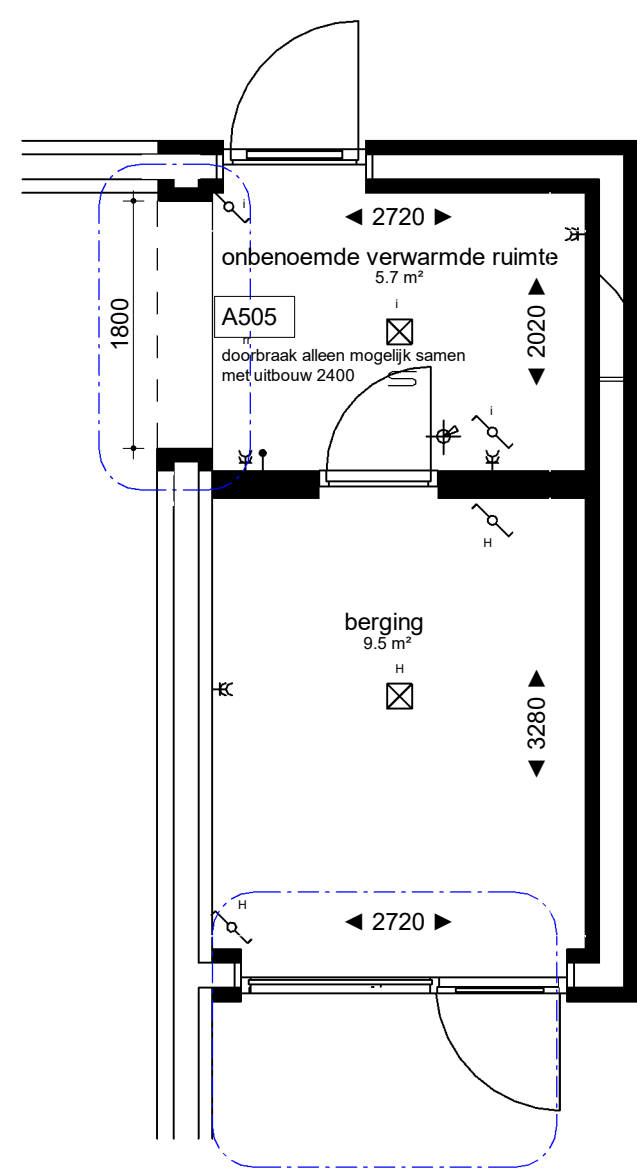

optie: A505 / A082
bwnr: I21, I24, K7, J2, J5

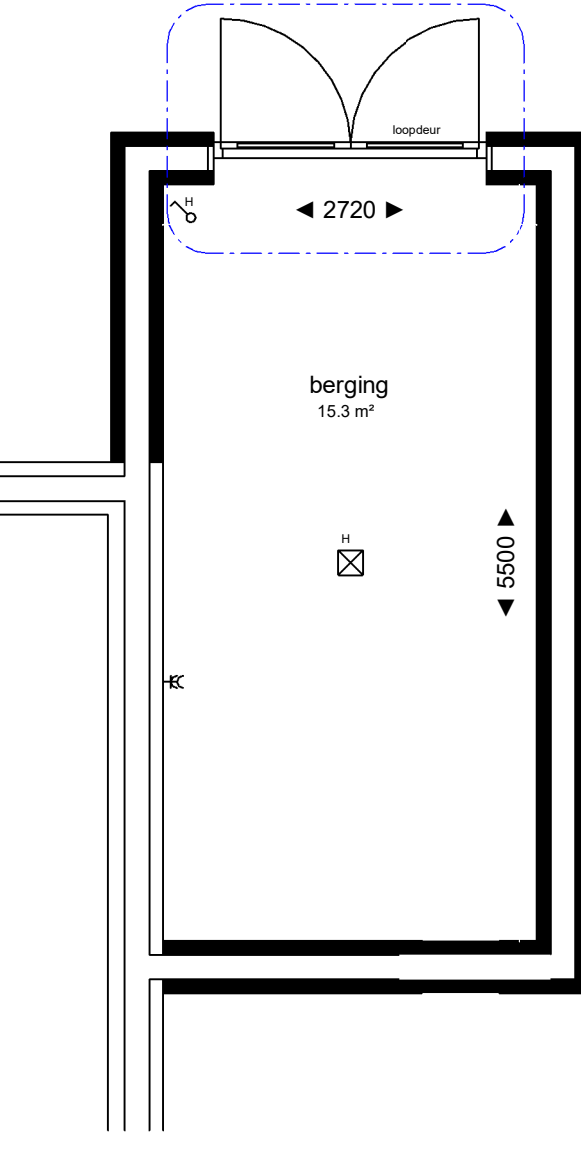

optie: A503

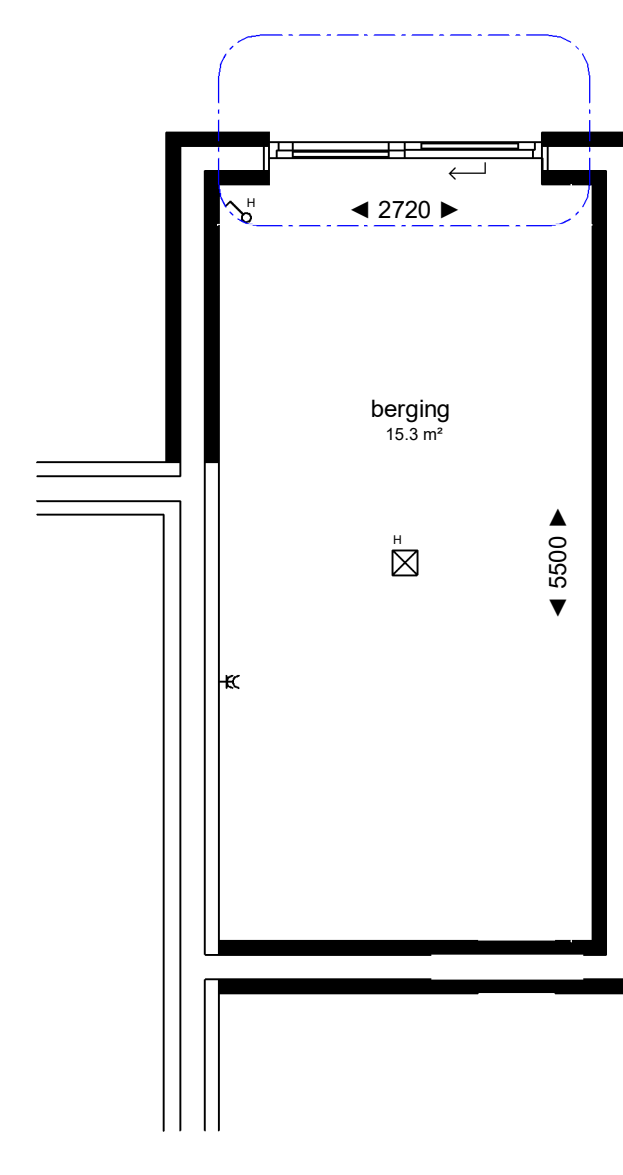

optie: A504

	Project	Doonheide 2, fase 1A te Gemert	Project nummer	21-2246
	Opdrachtgever	Keizersberg Vastgoed b.v.	Status	definitief
	Onderdeel	opties berging rijwoningen	Schaal	1:50 / 1:100
	Datum	27-06-2022	Getekend	TK
			Tekening nummer	